

# UNIVERSAL 320 / 320 R

## Benchtop centrifuge

The Universal range: The right model for every application



# UNIVERSAL 320 / 320 R



**View into the centrifuging chamber**  
showing the rotor 1494 with blood collection tubes

## TAKE ADVANTAGE OF EVERYTHING THIS MODEL HAS TO OFFER: A VERY WIDE RANGE OF USES THANKS TO ITS COMPREHENSIVE RANGE OF ACCESSORIES

The UNIVERSAL 320 and UNIVERSAL 320R are the most versatile of the Hettich centrifuges. They can be used for numerous standard applications at low speeds up to 4,193 RCF and a maximum volume of 200 ml. Conical 50 ml tubes can be centrifuged at up to 8,965 RCF. This enables rapid sedimentation of bacteria and yeast cells. A maximum RCF of 21,382 can be achieved with microlitre tubes.

### COMPREHENSIVE RANGE OF ACCESSORIES

The rotors available for the UNIVERSAL 320 and UNIVERSAL 320R models and their accessories allow them to be used for virtually all applications in daily routines in industrial, clinical and research labs. Ten swing-out rotors, seven fixed-angle rotors, one haematocrit rotor and three cyto-rotors are available. Both models can hold microtitre plates and tubes for the testing of chrome baths, in addition to standard tubes and cytology accessories.



**UNIVERSAL 320**  
Benchtop centrifuge

**Cat. No. 1401**



**UNIVERSAL 320 R**  
Benchtop centrifuge with cooling

**Cat. No. 1406**

# UNIVERSAL 320 / 320 R



## HIGH CAPACITY

The UNIVERSAL 320 model can centrifuge 4x200 ml in a single run. In addition, angle rotors are available for 6x94 ml and 32x15 ml cell culture tubes, 30x1.5 / 2 ml microlitre tubes and two cyto-rotors for 12 microscope slide preparations.

## CARRIER 1560 WITH CLAMP LOCK, WITH ONE-HAND OPERATION

The clamp lock can be operated easily with a single hand. With the clamp lock in an "Open" position, the lid can be readily put on the carrier and removed. If the clamp lock is in its central position then no aerosol release is possible and the carrier can be carried to the centrifuge, workbench or any other workplace. If the clamp lock is in the "Close" position then the carrier can be centrifuged without the risk of aerosol generation.

## RELIABLE COOLING

The temperature of the UNIVERSAL 320R can be set to any desired value in the range -20 to +40 °C. This allows thermolabile samples to be centrifuged without difficulty.



## AT A GLANCE



### FIELDS OF APPLICATION

#### Research

- Separation of mixtures in chemistry, pharmacy, biotechnology, etc.

#### Medical diagnostics

- Centrifugation of blood and urine samples
- Cytology

#### Industry

- Determination of the sulphate content of chrome baths

### EASE OF OPERATION

- Ergonomic operating and display elements
- 10 centrifugation programs
- Parameters can be quickly and easily set through a rotary button
- Single-hand lid closure

### SAFETY

- Lid locking
- Lid dropping prevention
- Automatic rotor recognition
- Imbalance shut-off
- Emergency lid lock release

### DESIGN

- Metal lid and housing
- Centrifuging chamber of stainless steel
- Motorised lid locking

### MAX. RCF

- 21,382

### MAX. CAPACITY

- 4x200 ml / 6x94 ml
- 12 cytological preparations

### OUR SERVICE

You will find information on Hettich partners in your country at [www.hettichlab.com](http://www.hettichlab.com)

# OVERVIEW OF CONTROL SYSTEM AND ROTORS

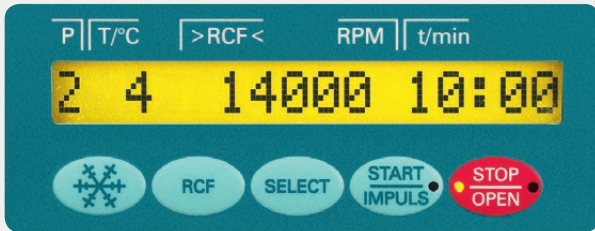

Control panel of the cooled UNIVERSAL 320 R

The UNIVERSAL 320 and 320 R models are quick and easy to operate using this variant of the N control panel. The parameters are selected with the Select key. An adjuster knob is used to set the values, and settings are stored by pressing the Start/Impulse key.

## SIMPLE OPERATION USING THE N-PLUS CONTROL SYSTEM

### KEYPAD

	Pre-cools the rotor chamber of the UNIVERSAL 320 R to the required temperature.
RCF	Switches from RPM to RCF display. Entry of the RCF in increments of 10. Input of rotor radius in mm in RCF mode.
SELECT	Guides the user through the menu options.
START IMPULS	Starts centrifugation. For short centrifugation steps.
STOP OPEN	Stops centrifugation manually. Opens the lid at standstill.

### DISPLAY

P	Program number. 10 centrifugation memories are available.
T/°C	Display of the temperature in the cooled UNIVERSAL 320 R. The temperature is infinitely variable between -20 °C to +40 °C. The temperature is set in increments of 1 °C.
>RCF<	Relative centrifugal force.
RPM	Speed indication. Entry in increments of 10.
t/min	Centrifugation time (max. 99 min : 59 s).
	Entry of the acceleration ramp 1–9
	Entry of the braking ramp 1–9

## Rotors

Quick overview of rotors and suitable accessories. The figures highlighted under the arrows refer to the pages where technical and ordering details are listed.

<p><b>Swing-out rotor, 4-place</b>  <math>\sphericalangle</math> 90°  <math>n = 4,500 \text{ min}^{-1}</math>                      max. RCF 3,328  <b>Cat. No. 1554</b></p>												<b>Page 7</b>
	<p><b>Swing-out rotor, 4-place</b>  <math>\sphericalangle</math> 90°  <math>n = 5,000 \text{ min}^{-1}</math>                      max. RCF 4,193  <b>Cat. No. 1494</b></p>											













































# ROTORS



	<p><b>Swing-out rotor, 4-place</b>  <math>\sphericalangle</math> 90°            n = 4,000 min<sup>-1</sup>            max. RCF 2,665  <b>Cat. No. 1624</b></p>	<p>max. 5 ml</p>	<p>1–100 ml</p>	<p>0.5 ml</p>	<p>1.6–10 ml</p>	<p>1.1–10 ml</p>		<p>15–50 ml</p>	<p>12–50 ml</p>	<p>10–85 ml</p>		<p>30 ml</p>	<p>Cyto</p> <p>→ <b>Page 14</b></p>
	<p><b>Swing-out rotor, 4-place</b>  <math>\sphericalangle</math> 90°            n = 4,500 min<sup>-1</sup>            max. RCF 3,328  <b>Cat. No. 1324</b></p>	<p>max. 5 ml</p>	<p>1–100 ml</p>	<p>0.5 ml</p>	<p>1.6–10 ml</p>	<p>1.1–10 ml</p>	<p>12 ml</p>	<p>15–50 ml</p>	<p>12–50 ml</p>	<p>10–85 ml</p>		<p>30 ml</p>	<p>→ <b>Page 17</b></p>
	<p><b>Swing-out rotor, 6-place</b>  <math>\sphericalangle</math> 90°            n = 4,000 min<sup>-1</sup>            max. RCF 2,701  <b>Cat. No. 1619</b></p>							<p>15/50 ml</p>					<p>→ <b>Page 20</b></p>
	<p><b>Swing-out rotor, 8-place</b>  <math>\sphericalangle</math> 90°            n = 4,000 min<sup>-1</sup>            max. RCF 2,415  <b>Cat. No. 1611</b></p>		<p>5–15 ml</p>	<p>1.6–10 ml</p>	<p>2.6–8.5 ml</p>								<p>→ <b>Page 20</b></p>
	<p><b>Swing-out rotor, 8-place</b>  <math>\sphericalangle</math> 45°            n = 5,000 min<sup>-1</sup>            max. RCF 3,857  <b>Cat. No. 1617</b></p>							<p>15/50 ml</p>					<p>→ <b>Page 21</b></p>
	<p><b>Swing-out rotor, 12-place</b>  <math>\sphericalangle</math> 55° / <math>\sphericalangle</math> 60° / <math>\sphericalangle</math> 80°            n = 5,000 min<sup>-1</sup>            max. RCF 4,193  <b>Cat. No. 1628</b></p>	<p>5–15 ml</p>		<p>1.6–10 ml</p>	<p>2.6–8.5 ml</p>								<p>→ <b>Page 21</b></p>
	<p><b>Swing-out rotor, 4-place</b>  <math>\sphericalangle</math> 90°            n = 4,000 min<sup>-1</sup>            max. RCF 1,896  <b>Cat. No. 1645</b></p>	<p>Microtitre plate</p>	<p>Culture plate</p>				<p>→ <b>Page 22</b></p>						
	<p><b>Swing-out rotor, 2-place</b>  <math>\sphericalangle</math> 90°            n = 4,000 min<sup>-1</sup>            max. RCF 2,218  <b>Cat. No. 1460</b></p>	<p>Microtitre plate</p>	<p>Culture plate</p>	<p>Deep well plate</p>	<p>Micronic system</p>	<p>Filter plate</p>							
		<p>Microtest plate (Terasaki)</p>	<p>PCR plate, 96-place</p>	<p>PCR strips</p>			<p>→ <b>Page 22</b></p>						
	<p><b>Angle rotor, 12-place</b>  <math>\sphericalangle</math> 45°            n = 15,000 min<sup>-1</sup>            max. RCF 16,602  <b>Cat. No. 1612</b></p>	<p>0.2–2.0 ml</p>					<p>→ <b>Page 23</b></p>						

# ROTORS



 <p><b>Angle rotor, 24-place</b>  <math>\sphericalangle</math> 40°  <math>n = 15,000 \text{ min}^{-1}</math>                      max. RCF 21,382  <b>Cat. No. 1420-B</b></p>	 0.2–2.0 ml	 0.5 ml										→ <b>Page 23</b>
 <p><b>Angle rotor, 30-place</b>  <math>\sphericalangle</math> 45°  <math>n = 14,000 \text{ min}^{-1}</math>                      max. RCF 21,255  <b>Cat. No. 1689-A</b></p>	 0.2–2.0 ml	 0.5 ml										→ <b>Page 24</b>
 <p><b>Angle rotor, 8-place</b>  <math>\sphericalangle</math> 45°  <math>n = 4,500 \text{ min}^{-1}</math>                      max. RCF 3,305  <b>Cat. No. 1418</b></p>	 5–15 ml	 1.6–10 ml	 1.1–10 ml	 12 ml	 15/50 ml	 12/50 ml	 50 ml					→ <b>Page 24</b>
 <p><b>Angle rotor, 6-place</b>  <math>\sphericalangle</math> 35°  <math>n = 9,000 \text{ min}^{-1}</math>                      max. RCF 9,509  <b>Cat. No. 1620A</b></p>	 max. 5 ml	 15–94 ml	 0.5 ml	 8.5–10 ml	 7.5–10 ml	 15/50 ml	 10–85 ml					→ <b>Page 25</b>
 <p><b>Angle rotor, 12-place</b>  <math>\sphericalangle</math> 35°  <math>n = 6,000 \text{ min}^{-1}</math>                      max. RCF 4,146  <b>Cat. No. 1613</b></p>	 max. 5 ml	 4–15 ml	 0.5 ml	 1.6–10 ml	 1.1–10 ml	 15 ml						→ <b>Page 26</b>
 <p><b>Angle rotor, 12-place</b>  <math>\sphericalangle</math> 35°  <math>n = 12,000 \text{ min}^{-1}</math>                      max. RCF 16,582  <b>Cat. No. 1615</b></p>	 max. 5 ml	 4–15 ml	 0.5 ml	 1.6–10 ml	 1.6–10 ml	 15 ml						→ <b>Page 27</b>
 <p><b>Hematocrit rotor, 24-place</b>  <math>n = 15,000 \text{ min}^{-1}</math>                      max. RCF 21,382  <b>Cat. No. 1650</b></p>										 standard capillaries		→ <b>Page 27</b>
 <p><b>Cyto rotor, 6-place</b>  <math>n = 4,000 \text{ min}^{-1}</math>                      max. RCF 2,039  <b>Cat. No. 1626</b></p>	Detailed information on our comprehensive range of cyto accessories is provided in a separate brochure. We will be pleased to send one to you on request.										 Cyto	
 <p><b>Cyto rotor, 12-place</b>  <math>n = 2,000 \text{ min}^{-1}</math>                      max. RCF 438  <b>Cat. No. 1515</b></p>											 Cyto	
 <p><b>Disk rotor, 12-place</b>  <math>n = 2,000 \text{ min}^{-1}</math>                      max. RCF 438  <b>Cat. No. 1520</b></p>											 Cyto	

Accessories for accommodating additional tubes e.g. stool tubes or spin columns on request. The capacity of the vessels is given as the nominal volume according to the manufacturer. The filling volume can be different.

# ACCESSORIES



## Swing-out rotor, 4-place



illustrated with carriers 1560  
with single-hand clamp lock  
and lids 1561 with bio-containment<sup>3)</sup>

∠ 90°  
n = 4,500 min<sup>-1</sup>  
max. RCF 3,328



### Carrier 1565

The 1565 carrier is also available  
without a lid and clamp lock.<sup>4)</sup>

## Cat. No. (without carriers) 1554

capacity in ml	1.5	2.0	5	5	6	7	9	15	15	25	50	85
∅ x L in mm	11 x 38		17 x 59	12 x 75	12 x 82	12 x 100	14 x 100	17 x 100	18 x 102	24 x 100	34 x 100	38 x 101
<b>Cat. No.</b>	<b>2078</b>	<b>0536</b>	-	<b>0553<sup>2)</sup></b>	<b>0501<sup>2)</sup></b>	<b>0578<sup>2)</sup></b>	<b>0500<sup>2)</sup></b>	<b>0518<sup>2)</sup></b>	<b>Corex<sup>®</sup></b>	<b>0519<sup>2)</sup></b>	<b>0521<sup>2)</sup></b>	<b>0549</b>
<b>lid with bio-containment<sup>3)</sup></b> <b>Cat. No. 1561</b>												
<b>carrier</b> <b>Cat. No. 1560</b>												
<b>Cat. No.</b>	<b>1571</b>	<b>1593</b>	<b>1589</b>				<b>1588</b>	<b>1572</b>	<b>1573</b>	<b>1574</b>	<b>1575</b>	
boring ∅ x L in mm	11.5 x 39		17 x 52	13.5 x 60			17.5 x 60	18.5 x 74		25.2 x 66	35.2 x 69	38.5 x 74
tubes per rotor	56		16	28			20	16	4			
max. RCF <sup>2)</sup> upper/lower	3,328 / 2,332		3,328	3,215			3,215	3,260	3,056	3,147	3,260	
radius in mm upper/lower	147 / 103		147	142			142	144	135	139	144	
run-up in sec	28											
run-down in sec, braked	31											
temperature in °C <sup>1)</sup>	-8											

capacity in ml	100	125	150	200	1.1-1.4	2.6-3.4	4.9	2.7-3	4.5-5	4-5.5	7.5-8.5	9-10
∅ x L in mm	44 x 100	51 x 100	51 x 116	56 x 112	8 x 66	13 x 65	13 x 90	11 x 66	11 x 92	15 x 75	15 x 92	16 x 92
<b>Cat. No.</b>	<b>0526<sup>2)</sup></b>	-	-	<b>0555</b>	<b>blood collection/urine tubes</b>							
<b>lid with bio-containment<sup>3)</sup></b> <b>Cat. No. 1561</b>												
<b>carrier</b> <b>Cat. No. 1560</b>												
<b>Cat. No.</b>	<b>1576</b>	<b>1594</b>	-	<b>1589</b>	<b>1588</b>							
boring ∅ x L in mm	45.5 x 69	52 x 77		57 x 77	13.5 x 60						17.5 x 60	
tubes per rotor	4			28				20				
max. RCF <sup>2)</sup>	3,147	3,328		3,215								
radius in mm	139	147		142								
run-up in sec	28											
run-down in sec, braked	31											
temperature in °C <sup>1)</sup>	-8											

<sup>1)</sup> Lowest attainable temperature in precooled refrigerated centrifuges at max. speed. Lower temperatures can be attained by reducing the speed.

<sup>2)</sup> Please note that the RCF values indicated refer only to rotor performance. The max. permissible RCF of tubes used should be verified with the individual manufacturers. The max. RCF for glass tubes annotated with footnote <sup>2)</sup> is 4,000.

<sup>3)</sup> Tested by the TÜV in conformity with DIN EN 61010, section 2 - 020.

<sup>4)</sup> With the E3905 add-on kit and the 4783 lid, the 4785 carrier can be converted at a later time to a 4780 carrier with single-hand clamp lock.

<sup>5)</sup> When using these tubes, carrier 1560 cannot be closed with lid 1561.

# ACCESSORIES



illustrated with carriers 1560  
with single-hand clamp lock  
and lids 1561 with bio-containment<sup>3)</sup>



illustrated with carriers 1560

## Swing-out rotor 1554

capacity in ml	10	1.6-5	4-7	4-7	8.5-10	12	11	15	30	50
Ø x L in mm	15x102	13x75	13x100	16x75	16x100	17x102	16x110	17x120	25x110	29x115
<b>Cat. No.</b>	<b>blood collection /urine tubes</b>						<b>IVF (Nunc®)</b>	<b>0509</b>	-	<b>0513</b>
<b>lid with bio-containment<sup>3)</sup></b> <b>Cat. No. 1561</b>										
<b>carrier</b> <b>Cat. No. 1560</b>										
<b>Cat. No.</b>	<b>1588</b>	<b>1589</b>	<b>1588</b>	<b>1591</b>	<b>1581</b>	<b>1577</b>	<b>1595</b>	<b>1578</b>	<b>1579</b>	
boring Ø x L in mm	17.5x60	13.5x60	17.5x60	17.5x74	17.5x74	17x77	17x77	26x77	30x77	
tubes per rotor	20	28	20	12	16	8	12	4		
max. RCF <sup>2)</sup>	3,215					3,260	3,328			
radius in mm	142					144	147			
run-up in sec	28									
run-down in sec, braked	31									
temperature in °C <sup>1)</sup>	-8									

capacity in ml	12	25	30	50	10	30	50	85	94	30
Ø x L in mm	17x100	25x90	25x110	29x115	16x80	26x95	29x107	38x106	38x102	44x105
<b>Cat. No.</b>	-	-	-	-	-	<b>0545</b>	<b>0546</b>	<b>0547</b>	<b>0538<sup>6)</sup></b>	<b>0534<sup>7)</sup></b>
<b>lid with bio-containment<sup>3)</sup></b> <b>Cat. No. 1561</b>										
<b>carrier</b> <b>Cat. No. 1560</b>										
<b>Cat. No.</b>	<b>1581</b>	<b>1582</b>	<b>1583</b>	<b>1584</b>	<b>1585</b>	<b>1586</b>	<b>1575</b>	<b>1587</b>		
boring Ø x L in mm	17.5x74	26x65	30x77	16.5x60	26x74	29x74	38.5x74	45x71		
tubes per rotor	16	4		20	4					
max. RCF <sup>2)</sup>	3,260	3,328		3,215	3,260					3,192
radius in mm	144	147		142	144					141
run-up in sec	28									
run-down in sec, braked	31									
temperature in °C <sup>1)</sup>	-8									

<sup>1)</sup> Lowest attainable temperature in precooled refrigerated centrifuges at max. speed. Lower temperatures can be attained by reducing the speed.

<sup>2)</sup> Please note that the RCF values indicated refer only to rotor performance. The max. permissible RCF of tubes used should be verified with the individual manufacturers. The max. RCF for glass tubes annotated with footnote <sup>2)</sup> is 4,000.

<sup>3)</sup> Tested by the TÜV in conformity with DIN EN 61010, section 2 - 020.

<sup>5)</sup> When using these tubes, carrier 1560 cannot be closed with lid 1561.



# ACCESSORIES











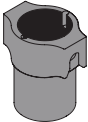

























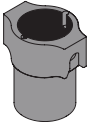





illustrated with carriers 1559









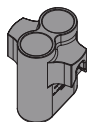

illustrated with carriers 1563

## Swing-out rotor 1554

capacity in ml	5	6	7	9	15	2.6–3.4	2.7–3	4–5.5	4.5–5	4.9	9–10	10	1.6–5	4–7	4–7
Ø x L in mm	12x75	12x82	12x100	14x100	17x100	13x65	11x66	15x75	11x92	13x90	16x92	10x102	13x75	13x100	16x75
<b>Cat. No.</b>	<b>0553<sup>2)</sup></b>	<b>0501<sup>2)</sup></b>	<b>0578<sup>2)</sup></b>	<b>0500<sup>2)</sup></b>	<b>0518<sup>2)</sup></b>	<b>blood collection/urine tubes</b>									
 <b>carrier</b> <b>Cat. No. 1559</b>															
															
<b>Cat. No.</b>	<b>1486</b>			<b>1482A</b>	<b>1486</b>	<b>1482A</b>	<b>1486</b>	<b>1482A</b>	<b>1486</b>	<b>1482A</b>	<b>1486</b>	<b>1482A</b>	<b>1486</b>	<b>1482A</b>	<b>1486</b>
boring Ø x L in mm	13.4x57.5			17.5x81		13.4x57.5		17.5x81		1.4x57.5		17.5x81		13.4x57.5	
tubes per rotor	20			16		20		16		20		16		20	
max. RCF <sup>2)</sup>	3,192			3,260		3,192		3,124		3,192		3,260		3,192	
radius in mm	141			144		141		138		141		144		141	
run-up in sec	28														
run-down in sec, braked	31														
temperature in °C <sup>1)</sup>	-8														

capacity in ml	8.5–10	8	12	15	50	12	50	
Ø x L in mm	16x100	16x125	17x102	17x120	29x115	17x100	29x115	
<b>Cat. No.</b>	<b>blood/urine tubes</b>			<b>0509</b>	<b>0513</b>	-	-	
 <b>carrier</b> <b>Cat. No. 1559</b>								
								
<b>Cat. No.</b>	<b>1482A</b>	<b>1482A<sup>9)</sup></b>	<b>1487</b>	<b>1483A</b>	<b>1484</b>	<b>1482A</b>	<b>1484<sup>9)</sup></b>	
boring Ø x L in mm	17.5x81		17.5x74		17x100		30x98	
tubes per rotor	16		12		16		4	
max. RCF <sup>2)</sup>	3,260	3,328	3,147	3,351	3,305	3,260	3,305	
radius in mm	144	147	139	148	146	144	146	
run-up in sec	28							
run-down in sec, braked	31							
temperature in °C <sup>1)</sup>	-8							

capacity in ml	12	15	50	50
Ø x L in mm	17x100	17x120	29x115	29x115
<b>Cat. No.</b>	-	<b>0509</b>	<b>0513</b>	-
 <b>carrier</b> <b>Cat. No. 1563</b>				
				
<b>Cat. No.</b>	<b>1592</b>		-	-
boring Ø x L in mm	17x87	17.5x74	30x87	30x87
tubes per rotor	8			
max. RCF <sup>2)</sup>	3,260			
radius in mm	144			
run-up in sec	28			
run-down in sec, braked	31			
temperature in °C <sup>1)</sup>	-8			

<sup>6)</sup> The screw cap for tube No. 0538 is available with Cat. No. 0539. Dimensions with cap 38 x 110 mm.

<sup>7)</sup> A rubber stopper for closing the tube is available under Cat. No. 0535.

The tube may not be centrifuged with the stopper. The stopper only serves to close the tube for agitating or mixing.

<sup>9)</sup> Please remove the inserts.

# ACCESSORIES



## Swing-out rotor, 4-place



illustrated with carriers 1425

∠ 90°  
n = 5,000 min<sup>-1</sup>  
max. RCF 4,193

### Cat. No. (without carriers) 1494

capacity in ml	1.5	2.0	1	3	5	6	7	9	15	25	50	100	suspension for cyto accessories
∅ x L in mm	11 x 38		6 x 45	10 x 60	12 x 75	12 x 82	12 x 100	14 x 100	17 x 100	24 x 100	34 x 100	44 x 100	
Cat. No.	<b>2078</b>	<b>0536</b>	<b>Rhesus</b>	<b>-</b>	<b>0553<sup>2)</sup></b>	<b>0501<sup>2)</sup></b>	<b>0578<sup>2)</sup></b>	<b>0500<sup>2)</sup></b>	<b>0518<sup>2)</sup></b>	<b>0519<sup>2)</sup></b>	<b>0521<sup>2)</sup></b>	<b>0526<sup>2)</sup></b>	<b>cyto chambers<sup>8)</sup></b>
<b>carrier</b> <b>Cat. No. 1425</b>													
<b>Cat. No.</b>	<b>1444</b>		<b>1432</b>	<b>1433</b>	<b>1438</b>	<b>1434</b>	<b>1431</b>		<b>1435</b>		<b>1436</b>	<b>1437</b>	<b>1452</b>
boring ∅ x L in mm	11.5 x 38		6.5 x 34	10.5 x 40	13.4 x 50	12.7 x 60	17.5 x 84		25.5 x 84	35.5 x 84	45.5 x 86		-
tubes per rotor	36		144	56	28	48	28		8	4			
max. RCF <sup>2)</sup>	3,885		3,969	3,913								3,801	2,739
radius in mm	139		142	140								136	98
run-up in sec	30												
run-down in sec, braked	32												
temperature in °C <sup>1)</sup>	-10												

capacity in ml	2.6–3.4	2.7–3	4–5.5	4.5–5	4.9	7.5–8.5	9–10	1.6–5	4–7	4–7	8.5–10	15	50	50
∅ x L in mm	13 x 65	11 x 66	15 x 75	11 x 92	13 x 90	15 x 92	16 x 92	13 x 75	13 x 100	16 x 75	16 x 100	17 x 120	29 x 115	29 x 115
Cat. No.	<b>blood collection / urine tubes</b>											<b>0509</b>	<b>0513</b>	<b>-</b>
<b>carrier</b> <b>Cat. No. 1425</b>														
<b>Cat. No.</b>	<b>1438</b>		<b>1441</b>	<b>1438</b>	<b>1441</b>	<b>1439</b>	<b>1438</b>	<b>1441</b>		<b>1441</b>		<b>1442</b>	<b>1443</b>	<b>1737</b>
boring ∅ x L in mm	13.4 x 50		16.5 x 50	13.4 x 50	16.5 x 50	17 x 45	13.4 x 50	16.5 x 50		16.5 x 50		17 x 90	30 x 90	30 x 90
tubes per rotor	28						16	28		4				
max. RCF <sup>2)</sup>	3,913											4,081		
radius in mm	140											146		
run-up in sec	30													
run-down in sec, braked	32													
temperature in °C <sup>1)</sup>	-10													

<sup>1)</sup> Lowest attainable temperature in precooled refrigerated centrifuges at max. speed. Lower temperatures can be attained by reducing the speed.

<sup>2)</sup> Please note that the RCF values indicated refer only to rotor performance. The max. permissible RCF of tubes used should be verified with the individual manufacturers. The max. RCF for glass tubes annotated with footnote <sup>2)</sup> is 4,000.

<sup>5)</sup> When using these tubes, carrier 1427 cannot be closed with lid 1421.

# ACCESSORIES



illustrated with carriers 1427

## Swing-out rotor 1494

capacity in ml	1.5	2.0	1	3	5	6	7	9	15	25	50	1.1–1.4	2.6–3.4	2.7–3	
Ø x L in mm	11 x 38	11 x 38	6 x 45	10 x 60	12 x 75	12 x 82	12 x 100	14 x 100	17 x 100	24 x 100	34 x 100	8 x 66	13 x 65	11 x 66	
<b>Cat. No.</b>	<b>2078</b>	<b>0536</b>	<b>Rhesus</b>	<b>-</b>	<b>0553<sup>2)</sup></b>	<b>0501<sup>2)</sup></b>	<b>0578<sup>2)</sup></b>	<b>0500<sup>2)</sup></b>	<b>0518<sup>2)</sup></b>	<b>0519<sup>2)</sup></b>	<b>0521<sup>2)</sup></b>	<b>blood/urine tubes</b>			
<b>lid</b> <b>Cat. No. 1421</b>															
<b>carrier</b> <b>Cat. No. 1427</b>															
<b>Cat. No.</b>	<b>5277</b>	<b>1357</b>	<b>1327</b>	<b>1732</b>	<b>5229</b>	<b>5230</b>	<b>5237</b>	<b>5231</b>	<b>5232</b>	<b>5233</b>	<b>5278</b>	<b>1732</b>	<b>5229</b>		
boring Ø x L in mm	11.5 x 38	6.5 x 23	10.5 x 23	13.4 x 58	12.5 x 44	12.4 x 87	15 x 73	17.8 x 87	25.5 x 87	35.5 x 87	9 x 41	13.4 x 58	12.5 x 44		
tubes per rotor	36	120	48	32	48	48	24		8	4	48	32	48		
max. RCF <sup>2)</sup>	4,109	4,081	4,053	4,025	4,053	3,941					4,109	4,025	4,053		
radius in mm	147	146	145	144	145	141					147	144	145		
run-up in sec	30														
run-down in sec, braked	32														
temperature in °C <sup>1)</sup>	-7														

capacity in ml	4–5.5	4.5–5	4.9	7.5–8.5	9–10	1.6–5	4–7		8.5–10	15	50	25	30	50	
Ø x L in mm	15 x 75	11 x 92	13 x 90	15 x 92	16 x 92	13 x 75	13 x 100	16 x 75	16 x 100	17 x 120	29 x 115	25 x 90	25 x 110	29 x 115	
<b>Cat. No.</b>	<b>blood collection/urine tubes</b>										<b>0509</b>	<b>0513</b>	<b>-</b>	<b>-</b>	<b>-</b>
<b>lid</b> <b>Cat. No. 1421</b>															
<b>carrier</b> <b>Cat. No. 1427</b>															
<b>Cat. No.</b>	<b>5279</b>	<b>5230</b>	<b>1732</b>	<b>5279</b>	<b>5271<sup>9)</sup></b>	<b>1732</b>		<b>5271</b>	<b>5231</b>	<b>5275</b>	<b>5276</b>	<b>1731</b>	<b>5272</b>	<b>5233<sup>9)</sup></b>	
boring Ø x L in mm	15.6 x 41	12.4 x 87	13.4 x 58	15.6 x 41	17 x 66	13.4 x 58		17 x 66	17.8 x 87	17 x 90	30 x 90	25.5 x 72	25.5 x 85	35.5 x 87	
tubes per rotor	20	48	32	20		32		20	24	4		8	4	4	
max. RCF <sup>2)</sup>	4,109	3,941	4,025	4,109	3,969	4,025		3,969	3,941	4,165	4,053	3,969	4,025	4,053	
radius in mm	147	141	144	147	142	144		142	141	149	145	142	144	145	
run-up in sec	30														
run-down in sec, braked	32														
temperature in °C <sup>1)</sup>	-7														

<sup>8)</sup> Please ask for our detailed cyto brochure.



<sup>9)</sup> Please remove the inserts.

# ACCESSORIES

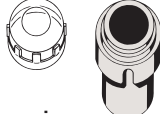

illustrated with carriers 1495  
and lids 1492 with bio-containment<sup>3)</sup>

## Swing-out rotor 1494

capacity in ml	0.5	1.5	2.0	1	3	5/6/7	9	15	25	50	94	
Ø x L in mm	10.7 x 36	11 x 38		6 x 45	10 x 60	12 x 75 / 82 / 100		14 x 100	17 x 100	24 x 100	34 x 100	38 x 102
<b>Cat. No.</b>	<b>Pediatric</b>	<b>2078</b>	<b>0536</b>	<b>Rhesus</b>	-	<b>0553<sup>2)</sup> / 0501<sup>2)</sup> / 0578<sup>2)</sup></b>		<b>0500<sup>2)</sup></b>	<b>0518<sup>2)</sup></b>	<b>0519<sup>2)</sup></b>	<b>0521<sup>2)</sup></b>	<b>0549</b>
<b>lid with bio-containment<sup>3)</sup></b> <b>Cat. No. 1492</b>												
<b>carrier</b> <b>Cat. No. 1495</b>												
<b>Cat. No.</b>	<b>1351</b>	<b>1351</b>		<b>1339</b>	<b>1343</b>	<b>1383</b>		<b>1329</b>		<b>1330</b>	<b>1331</b>	<b>1396</b>
boring Ø x L in mm	11.2 x 38	11.2 x 38		6.5 x 34	10.5 x 43	13.4 x 48		17.6 x 91		25.2 x 87	35.2 x 87	38.5 x 92
tubes per rotor	20	20		108	36	20		16		4		
max. RCF <sup>2)</sup>	3,745	3,857		4,081	4,137	4,025		3,997		3,829	3,801	4,109
radius in mm	134	138		146	148	144		143		137	136	147
run-up in sec	30											
run-down in sec, braked	32											
temperature in °C <sup>1)</sup>	-10											

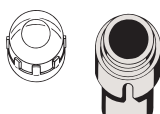
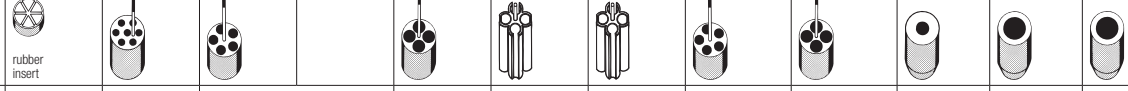
capacity in ml	100	1.1–1.4	2.7–5	2.6–4.9	4–8.5	9–10	10	1.6–7	4–10	15	30	50
Ø x L in mm	44 x 100	8 x 66	11 x 66 / 92	13 x 65 / 90	15 x 75 / 92	16 x 92	15 x 102	13 x 75 / 100	16 x 75 / 100	17 x 120	25 x 110	29 x 115
<b>Cat. No.</b>	<b>0526<sup>2)</sup></b>	<b>blood collection / urine tubes</b>								<b>0509</b>	-	<b>0513</b>
<b>lid with bio-containment<sup>3)</sup></b> <b>Cat. No. 1492</b>												
<b>carrier</b> <b>Cat. No. 1495</b>												
<b>Cat. No.</b>	<b>0761</b>	<b>1457</b>	<b>1383</b>		<b>1459</b>	<b>1329</b>	<b>1329<sup>3)</sup></b>	<b>1383</b>	<b>1348</b>	<b>1347</b>	<b>1365</b>	<b>1384</b>
boring Ø x L in mm	45.6 x 98	9 x 47	13.4 x 48		15.6 x 47	17.6 x 91		13.4 x 48	16.5 x 56	17 x 90	26 x 80	30 x 90
tubes per rotor	4	28	20		16	16		20	16	4		
max. RCF <sup>2)</sup>	4,025	4,053	4,025		4,053	3,997	4,193	4,025		4,193		
radius in mm	144	145	144		145	143	150	144		150		
run-up in sec	30											
run-down in sec, braked	32											
temperature in °C <sup>1)</sup>	-10											

<sup>1)</sup> Lowest attainable temperature in precooled refrigerated centrifuges at max. speed. Lower temperatures can be attained by reducing the speed.



















<sup>2)</sup> Please note that the RCF values indicated refer only to rotor performance. The max. permissible RCF of tubes used should be verified with the individual manufacturers. The max. RCF for glass tubes annotated with footnote <sup>2)</sup> is 4,000.

<sup>3)</sup> Tested by the TÜV in conformity with DIN EN 61010, section 2 - 020.

# ACCESSORIES



## Swing-out rotor 1494

capacity in ml	12	25	30	50	10	30	50	85	30
Ø x L in mm	17 x 100	25 x 90	25 x 110	29 x 115	16 x 80	26 x 95	29 x 107	38 x 106	44 x 105
<b>Cat. No.</b>	-	-	-	-	-	<b>0545</b>	<b>0546</b>	<b>0547</b>	<b>0534</b> <sup>7)</sup>
<b>lid with bio-containment</b> <sup>9)</sup> <b>Cat. No. 1492</b>									 chrome bath tube
<b>carrier</b> <b>Cat. No. 1495</b>									 rubber insert
<b>Cat. No.</b>	<b>6311</b>	<b>1363</b>	<b>1365</b>	<b>6318</b>	<b>1348</b>	<b>4417</b>	<b>4416</b>	<b>1396</b>	<b>0765</b>
boring Ø x L in mm	17 x 80	26 x 72	26 x 80	29.5 x 80	16.5 x 56	26 x 83	29 x 93	38.5 x 92	45.9 x 98
tubes per rotor	4	4			16	4			
max. RCF <sup>2)</sup>	4,193	3,689	4,193		4,025	3,857	4,137	4,109	3,997
radius in mm	150	132	150		144	138	148	147	143
run-up in sec	30								
run-down in sec, braked	32								
temperature in °C <sup>1)</sup>	-10								

<sup>7)</sup> A rubber stopper for closing the tube is available under Cat. No. 0535.  
The tube may not be centrifuged with the stopper. The stopper only serves to close the tube for agitating or mixing.

<sup>9)</sup> Please remove the inserts.

# ACCESSORIES





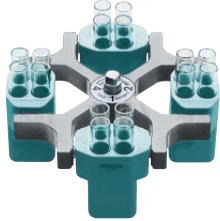







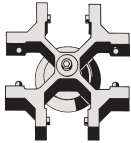







## Swing-out rotor, 4-place

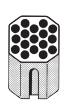

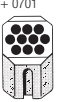



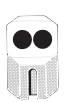



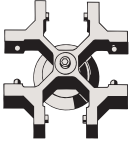







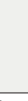

illustrated with carriers 1369

∠ 90°  
n = 4,000 min<sup>-1</sup>  
max. RCF 2,665

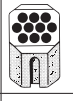
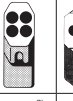
### Cat. No. (without carriers) 1624

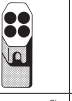
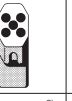
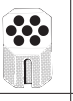
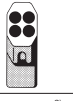
capacity in ml	5	6	7	9	15	20	25	45	50			
∅ x L in mm	12x75	12x82	12x100	14x100	17x100	21x100	24x100	31x100	34x100			
<b>Cat. No.</b>	<b>0553<sup>2)</sup></b>	<b>0501<sup>2)</sup></b>	<b>0578<sup>2)</sup></b>	<b>0500<sup>2)</sup></b>	<b>0518<sup>2)</sup></b>	-	<b>0519<sup>2)</sup></b>	-	<b>0521<sup>2)</sup></b>			
 <b>rotor</b> <b>Cat. No. 1624</b>												
												
<b>Cat. No.</b>	<b>1369-91</b>	<b>1372</b>	<b>1369-92</b>	<b>1370</b>	<b>1741</b>	<b>1369</b>	<b>1742</b>	<b>1346</b>	<b>1745</b>	<b>1345</b>	<b>1746</b>	
boring ∅ x L in mm	12.5x64.4	13.5x65	12.5x71.5	14.6x74	14.6x78	17.6x74	17.6x78	21.5x74	26x78	32x74	35x78	
tubes per rotor	16	68	16	20	40	16	28	8		4		
max. RCF <sup>2)</sup>	2,057	2,164	2,308		2,415	2,308	2,451	2,361	2,451	2,361	2,451	
radius in mm	115	121	129		135	129	137	132	137	132	137	
run-up in sec	20											
run-down in sec, braked	25											
temperature in °C <sup>1)</sup>	-17				-15		-17		-15			

capacity in ml	1.1–1.4	2.6–3.4	4–5.5	4.9	1.6–5	4–7	1.6–5	4–7	4–7	8.5–10	30	suspension for cyto accessories
∅ x L in mm	8x66	13x65	15x75	13x90	13x75	13x75	13x75	16x75	13x100	16x100	26x95	
<b>Cat. No.</b>	<b>blood collection / urine tubes</b>										<b>0545</b>	<b>cyto chambers<sup>®)</sup></b>
 <b>rotor</b> <b>Cat. No. 1624</b>												
												
<b>Cat. No.</b>	<b>1741</b>	<b>1742</b>	<b>1741</b>	<b>1741</b>	<b>1369<sup>®)</sup></b>	<b>1742</b>	<b>1369<sup>®)</sup></b>	<b>1370<sup>®)</sup></b>	<b>1739</b>	<b>1369<sup>®)</sup></b>	<b>1745</b>	<b>1660</b>
boring ∅ x L in mm	14.6x78	17.6x78	14.6x78	14.6x78	17.6x74	17.6x78	17.6x74	14.6x74	13.5x78	17.6x74	26x78	-
tubes per rotor	40	28	40	40	16	28	16	20	28	16	8	4
max. RCF <sup>2)</sup>	2,415	2,325	2,451	2,129	2,361	2,325	2,361		2,451	2,361	2,451	1,646
radius in mm	135	130	137	119	132	130	132		137	132	137	92
run-up in sec	22											
run-down in sec, braked	25											

<sup>1)</sup> Lowest attainable temperature in pre-cooled refrigerated centrifuges at max. speed. Lower temperatures can be attained by reducing the speed.

<sup>2)</sup> Please note that the RCF values indicated refer only to rotor performance. The max. permissible RCF of tubes used should be verified with the individual manufacturers. The max. RCF for glass tubes annotated with footnote <sup>2)</sup> is 4,000.











<sup>3)</sup> Tested by the TÜV in conformity with DIN EN 61010, section 2 - 020.























# ACCESSORIES



illustrated with carriers 1481  
and lids 1492 with bio-containment<sup>3)</sup>

## Swing-out rotor 1624

capacity in ml	1.5	2.0	1	3	4
Ø x L in mm	11 x 38		6 x 45	10 x 60	12 x 60
<b>Cat. No.</b>	<b>2078</b>	<b>0536</b>	<b>Rhesus</b>	-	-
 <b>carrier</b> <b>Cat. No. 1366</b>					
					
<b>Cat. No.</b>	<b>5277</b>		<b>1357</b>	<b>1327</b>	<b>1326</b>
boring Ø x L in mm	11.5 x 38		6.5 x 23	10.5 x 23	12.5 x 44
tubes per rotor	36		120	48	
max. RCF <sup>2)</sup>	1,968		1,950	1,932	
radius in mm	110		109	108	
run-up in sec	20				
run-down in sec, braked	25				
temperature in °C <sup>1)</sup>	-15				

capacity in ml	0.5	1.5	2.0	1	3	5/6/7	9	15	25	50	94
Ø x L in mm	10.7 x 36	11 x 38		6 x 45	10 x 60	12 x 75/82/100	14 x 100	17 x 100	24 x 100	34 x 100	38 x 102
<b>Cat. No.</b>	<b>Pediatric</b>	<b>2078</b>	<b>0536</b>	<b>Rhesus</b>	-	<b>0553<sup>2)</sup> / 0501<sup>2)</sup> / 0578<sup>2)</sup></b>	<b>0500<sup>2)</sup></b>	<b>0518<sup>2)</sup></b>	<b>0519<sup>2)</sup></b>	<b>0521<sup>2)</sup></b>	<b>0549</b>
<b>lid with bio-containment<sup>3)</sup></b> <b>Cat. No. 1492</b>  											
											
<b>Cat. No.</b>	<b>1351</b>			<b>1339</b>	<b>1343</b>	<b>1383</b>	<b>1329</b>		<b>1330</b>	<b>1331</b>	<b>1396</b>
boring Ø x L in mm	11.2 x 38			6.5 x 34	10.5 x 43	13.4 x 48	17.6 x 91		25.2 x 87	35.2 x 87	38.5 x 92
tubes per rotor	20			108	36	20	16		4		
max. RCF <sup>2)</sup>	2,379	2,451		2,594	2,630	2,558	2,540		2,433	2,415	2,612
radius in mm	133	137		145	147	143	142		136	135	146
run-up in sec	20										
run-down in sec, braked	25										
temperature in °C <sup>1)</sup>	-15										

<sup>8)</sup> Please ask for our detailed cyto brochure.

<sup>9)</sup> Please remove the inserts.

<sup>10)</sup> This combination permits no Vacutainers made of glass.

<sup>15)</sup> Packed in units of 10 pieces.

# ACCESSORIES



illustrated with carriers 1481  
and lids 1492 with bio-containment<sup>3)</sup>

## Swing-out rotor 1624

capacity in ml	100	1.1–1.4	2.7–5	2.6–4.9	4–8.5	9–10	10	1.6–7	4–10	5	15
Ø x L in mm	44 x 100	8 x 66	11 x 66 / 92	13 x 65 / 90	15 x 75 / 92	16 x 92	15 x 102	13 x 75 / 100	16 x 75 / 100	17 x 59	17 x 120
<b>Cat. No.</b>	<b>0526<sup>2)</sup></b>	<b>blood collection/urine tubes</b>								-	<b>0509</b>
<b>lid with bio-containment<sup>3)</sup></b> <b>Cat. No. 1492</b>											
<b>carrier</b> <b>Cat. No. 1481</b>											
<b>Cat. No.</b>	<b>0761</b>	<b>1457</b>	<b>1383</b>		<b>1459</b>	<b>1329</b>	<b>1329<sup>3)</sup></b>	<b>1383</b>	<b>1348</b>	<b>6341</b>	<b>1347</b>
boring Ø x L in mm	45.9 x 98	9 x 47	13.4 x 48		15.6 x 47	17.6 x 91		13.4 x 48	16.5 x 56	17 x 45	17 x 90
tubes per rotor	4	28	20		16			20	16	12	4
max. RCF <sup>2)</sup>	2,558	2,576	2,558		2,576	2,540	2,665	2,558	2,522	2,665	
radius in mm	143	144	143		144	142	149	143	141	149	
run-up in sec	20										
run-down in sec, braked	25										
temperature in °C <sup>1)</sup>	-15										

capacity in ml	50	12	25	30	50	10	30	50	85	30
Ø x L in mm	29 x 115	17 x 100	25 x 90	25 x 110	29 x 115	16 x 80	26 x 95	29 x 107	38 x 106	44 x 105
<b>Cat. No.</b>	<b>0513</b>	-	-	-	-	-	<b>0545</b>	<b>0546</b>	<b>0547</b>	<b>0534<sup>7)</sup></b>
<b>lid with bio-containment<sup>3)</sup></b> <b>Cat. No. 1492</b>										
<b>carrier</b> <b>Cat. No. 1481</b>										
<b>Cat. No.</b>	<b>1384</b>	<b>6311</b>	<b>1363</b>	<b>1365</b>	<b>6318</b>	<b>1348</b>	<b>4417</b>	<b>4416</b>	<b>1396</b>	<b>0765</b>
boring Ø x L in mm	30 x 90	17 x 80	26 x 72	26 x 80	29.5 x 80	16.5 x 56	26 x 83	29 x 93	38.5 x 92	45.9 x 98
tubes per rotor	4					16		4		
max. RCF <sup>2)</sup>	2,665		2,343	2,665		2,522	2,451	2,630	2,612	2,540
radius in mm	149		131	149		141	137	147	146	142
run-up in sec	20									
run-down in sec, braked	25									
temperature in °C <sup>1)</sup>	-15									

<sup>1)</sup> Lowest attainable temperature in precooled refrigerated centrifuges at max. speed. Lower temperatures can be attained by reducing the speed.

<sup>2)</sup> Please note that the RCF values indicated refer only to rotor performance. The max. permissible RCF of tubes used should be verified with the individual manufacturers. The max. RCF for glass tubes annotated with footnote <sup>2)</sup> is 4,000.

<sup>3)</sup> Tested by the TÜV in conformity with DIN EN 61010, section 2 - 020.



# ACCESSORIES



## Swing-out rotor, 4-place



illustrated with carriers 1490  
and lids 1492 with bio-containment<sup>3)</sup>

∠ 90°  
n = 4,500 min<sup>-1</sup>  
max. RCF 3,328

### Cat. No. (without carriers) 1324

capacity in ml	0.5	1.5	2.0	1	3	4	5	6	7	9	15	25
∅ x L in mm	10.7 x 36	11 x 38		6 x 45	10 x 60	10 x 88	12 x 75	12 x 82	12 x 100	14 x 100	17 x 100	24 x 100
<b>Cat. No.</b>	<b>Pediatric</b>	<b>2078</b>	<b>0536</b>	<b>Rhesus</b>	-	-	<b>0553<sup>2)</sup></b>	<b>0501<sup>2)</sup></b>	<b>0578<sup>2)</sup></b>	<b>0500<sup>2)</sup></b>	<b>0518<sup>2)</sup></b>	<b>0519<sup>2)</sup></b>
<b>lid with bio-containment<sup>3)</sup></b> <b>Cat. No. 1492</b>												
<b>carrier</b> <b>Cat. No. 1490</b>												
<b>Cat. No.</b>	<b>1351</b>			<b>1339</b>	<b>1343</b>	<b>1383</b>			<b>1329</b>		<b>1330</b>	
boring ∅ x L in mm	11.2 x 38			6.5 x 34	10.5 x 43	13.4 x 48			17.6 x 91		25.2 x 87	
tubes per rotor	20			108	36	20			16		4	
max. RCF <sup>2)</sup>	2,966	3,056		3,237	3,283	3,192			3,170		3,034	
radius in mm	131	135		143	145	141			140		134	
run-up in sec	27											
run-down in sec, braked	30											
temperature in °C <sup>1)</sup>	-6											

capacity in ml	50	94	100	1.1–1.4	2.6–3.4	4.9	2.7–3	4.5–5	4–5.5	7.5–8.5	9–10	10
∅ x L in mm	34 x 100	38 x 102	44 x 100	8 x 66	13 x 65	13 x 90	11 x 66	11 x 92	15 x 75	15 x 92	16 x 92	15 x 102
<b>Cat. No.</b>	<b>0521<sup>2)</sup></b>	<b>0549</b>	<b>0526<sup>2)</sup></b>	<b>blood collection/urine tubes</b>								
<b>lid with bio-containment<sup>3)</sup></b> <b>Cat. No. 1492</b>												
<b>carrier</b> <b>Cat. No. 1490</b>												
<b>Cat. No.</b>	<b>1331</b>	<b>1396</b>	<b>0761</b>	<b>1457</b>	<b>1383</b>			<b>1459</b>		<b>1329<sup>3)</sup></b>		
boring ∅ x L in mm	35.2 x 87	38.5 x 92	45.9 x 100.5	9 x 47	13.4 x 48			15.6 x 47		17.6 x 91		
tubes per rotor	4			28	20			16				
max. RCF <sup>2)</sup>	3,011	3,260	3,192	3,215	3,192			3,215		3,170	3,328	
radius in mm	133	144	141	142	141			142		140	147	
run-up in sec	27											
run-down in sec, braked	30											
temperature in °C <sup>1)</sup>	-6											

<sup>2)</sup> A rubber stopper for closing the tube is available under Cat. No. 0535.

The tube may not be centrifuged with the stopper. The stopper only serves to close the tube for agitating or mixing.

<sup>3)</sup> Please remove the inserts.

# ACCESSORIES



## Swing-out rotor 1324

capacity in ml	1.6–5	4–7	4–7	8.5–10	5	15	30	50	12	25	30	
Ø x L in mm	13x75	13x100	16x75	16x100	17x59	17x120	25x110	29x115	17x100	25x90	25x110	
<b>Cat. No.</b>	<b>blood collection /urine tubes</b>				-	<b>0509</b>	-	<b>0513</b>	-	-	-	
<b>lid with bio-containment<sup>3)</sup></b> <b>Cat. No. 1492</b>												
<b>carrier</b> <b>Cat. No. 1490</b>												
<b>Cat. No.</b>	<b>1383</b>	<b>1348</b>	<b>1348</b>	<b>1348</b>	<b>6341</b>	<b>1347</b>	<b>1356</b>	<b>1365</b>	<b>1384</b>	<b>6311</b>	<b>1363</b>	<b>1365</b>
boring Ø x L in mm	13.4x48	16.5x56	16.5x56	16.5x56	17x45	17x90	17x107	26x80	30x90	17x80	26x72	26x80
tubes per rotor	20	16	16	16	12	4	12	4	4	4	4	4
max. RCF <sup>2)</sup>	3,192	3,147	3,147	3,147	3,328	3,328	3,328	3,328	3,328	3,328	2,920	3,328
radius in mm	141	139	139	139	147	147	147	147	147	147	129	147
run-up in sec	27	27	27	27	27	27	27	27	27	27	27	27
run-down in sec, braked	30	30	30	30	30	30	30	30	30	30	30	30
temperature in °C <sup>1)</sup>	-6	-6	-6	-6	-6	-6	-6	-6	-6	-6	-6	-6

capacity in ml	50	10	30	50	85	30
Ø x L in mm	29x115	16x80	26x95	29x107	38x106	44x105
<b>Cat. No.</b>	-	-	<b>0545</b>	<b>0546</b>	<b>0547</b>	<b>0534<sup>7)</sup></b>
<b>lid with bio-containment<sup>3)</sup></b> <b>Cat. No. 1492</b>						
<b>carrier</b> <b>Cat. No. 1490</b>						
<b>Cat. No.</b>	<b>6318</b>	<b>1348</b>	<b>4417</b>	<b>4416</b>	<b>1396</b>	<b>0765</b>
boring Ø x L in mm	29.5x80	16.5x56	26x83	29x93	38.5x92	45.9x100.5
tubes per rotor	4	16	4	4	4	4
max. RCF <sup>2)</sup>	3,328	3,147	3,056	3,283	3,260	3,170
radius in mm	147	139	135	145	144	140
run-up in sec	27	27	27	27	27	27
run-down in sec, braked	30	30	30	30	30	30
temperature in °C <sup>1)</sup>	-6	-6	-6	-6	-6	-6

<sup>1)</sup> Lowest attainable temperature in precooled refrigerated centrifuges at max. speed. Lower temperatures can be attained by reducing the speed.

<sup>2)</sup> Please note that the RCF values indicated refer only to rotor performance. The max. permissible RCF of tubes used should be verified with the individual manufacturers. The max. RCF for glass tubes annotated with footnote <sup>2)</sup> is 4,000.



















<sup>3)</sup> Tested by the TÜV in conformity with DIN EN 61010, section 2 - 020.







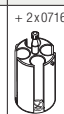









# ACCESSORIES



illustrated with carriers 1398

## Swing-out rotor 1324

capacity in ml	5	6	7	9	15	2.6–3.4	2.7–3	4–5.5	4.5–5	4.9	9–10	10
Ø x L in mm	12x75	12x82	12x100	14x100	17x100	13x65	11x66	15x75	11x92	13x90	16x92	15x102
<b>Cat. No.</b>	<b>0553<sup>2)</sup></b>	<b>0501<sup>2)</sup></b>	<b>0578<sup>2)</sup></b>	<b>0500<sup>2)</sup></b>	<b>0518<sup>2)</sup></b>	<b>blood collection/urine tubes</b>						
 <b>carrier</b> <b>Cat. No. 1398</b>												
												
<b>Cat. No.</b>	<b>1486</b>			<b>1482A</b>		<b>1486</b>		<b>1482A</b>	<b>1486</b>		<b>1482A</b>	
boring Ø x L in mm	13.4x57.5			17.5x81		13.4x57.5		17.5x81		13.4x57.5		17.5x81
tubes per rotor	20			16		20		16		20		16
max. RCF <sup>2)</sup>	3,147			3,192		3,147		2,875		3,147		3,192
radius in mm	139			141		139		127		139		141
run-up in sec	27											
run-down in sec, braked	30											
temperature in °C <sup>1)</sup>	-6											

capacity in ml	1.6–5	4–7	4–7	12	15	50	12	50	
Ø x L in mm	13x75	13x100	16x75	17x102	17x120	29x115	17x100	29x115	
<b>Cat. No.</b>	<b>blood/urine tubes</b>				<b>0509</b>	<b>0513</b>	-	-	
 <b>carrier</b> <b>Cat. No. 1398</b>									
									
<b>Cat. No.</b>	<b>1486</b>		<b>1482A</b>	<b>1487</b>	<b>1483A</b>	<b>1484</b>	<b>1482A</b>	<b>1484<sup>9)</sup></b>	
boring Ø x L in mm	13.4x57.5		17.5x81		17.5x74	17x100	30x98	17.5x81	30x98
tubes per rotor	20		16		12	16	4	16	4
max. RCF <sup>2)</sup>	3,147		3,034		3,102	3,305	3,260	3,192	3,260
radius in mm	139		134		137	146	144	141	144
run-up in sec	27								
run-down in sec, braked	30								
temperature in °C <sup>1)</sup>	-6								

<sup>5)</sup> When using these tubes, carrier 1490 cannot be closed with lid 1492.

<sup>7)</sup> A rubber stopper for closing the tube is available under Cat. No. 0535.

The tube may not be centrifuged with the stopper. The stopper only serves to close the tube for agitating or mixing.

<sup>9)</sup> Please remove the inserts.

# ACCESSORIES



## Swing-out rotor, 6-place



∠ 90°  
n = 4,000 min<sup>-1</sup>  
max. RCF 2,701

**Cat. No. (with carriers) 1619**

## Swing-out rotor, 8-place



∠ 90°  
n = 4,000 min<sup>-1</sup>  
max. RCF 2,415

**Cat. No. (without carriers) 1611**

capacity in ml	15	50
∅ x L in mm	17x120	29x115
<b>Cat. No.</b>	<b>0509</b>	<b>0513</b>



**rotor**  
**Cat. No. 1619**

<b>Cat. No.</b>	<b>1462-A</b>	-
boring ∅ x L in mm	17 x 84	30 x 87.5
tubes per rotor	6	
max. RCF <sup>2)</sup>	2,701	
radius in mm	151	
run-up in sec	20	
run-down in sec, braked	22	
temperature in °C <sup>1)</sup>	-15	

capacity in ml	5	6	7	10	15	2.6–3.4	2.7–3	4–5.5	4.5–5	7.5–8.5	1.6–5	4–7	4–7	8.5–10	
∅ x L in mm	12x75	12x82	12x100	17x70	13x100	17x100	13x65	11x66	15x75	11x92	15x92	13x75	13x100	16x75	16x100
<b>Cat. No.</b>	<b>0553<sup>2)</sup></b>	<b>0501<sup>2)</sup></b>	<b>0578<sup>2)</sup></b>	<b>2079</b>	-	<b>0518<sup>2)</sup></b>	<b>blood collection / urine tubes</b>								
<b>rotor</b> <b>Cat. No. 1611</b>															
<b>Cat. No.</b>	<b>1131-A</b>	<b>1643</b>	<b>1132-A</b>	<b>1643</b>	<b>1644</b>	<b>1131-A</b>	<b>1132-A</b>	<b>1643</b>	<b>1644</b>	<b>1131-A</b>	<b>1643</b>	<b>1132-A</b>	<b>1644</b>		
boring ∅ x L in mm	13x53	13.2x81	17.5x53	13.2x81	17.5x81	13x53	17.5x53	13.2x81	17.5x81	13x53	13.2x81	17.5x53	17.5x81		
tubes per rotor	8														
max. RCF <sup>2)</sup>	1,914	2,415	1,914	2,415	1,914	2,415	1,914	2,415	1,914	2,415	1,914	2,415	1,914	2,415	
radius in mm	107	135	107	135	107	135	107	135	107	135	107	135	107	135	
run-up in sec	20														
run-down in sec, braked	20														
temperature in °C <sup>1)</sup>	-16														

<sup>1)</sup> Lowest attainable temperature in pre-cooled refrigerated centrifuges at max. speed. Lower temperatures can be attained by reducing the speed.

<sup>2)</sup> Please note that the RCF values indicated refer only to rotor performance. The max. permissible RCF of tubes used should be verified with the individual manufacturers. The max. RCF for glass tubes annotated with footnote <sup>2)</sup> is 4,000.

# ACCESSORIES



## Swing-out rotor, 8-place



✧ 45°  
n = 5,000 min<sup>-1</sup>  
max. RCF 3,857

**Cat. No. (with carriers) 1617**



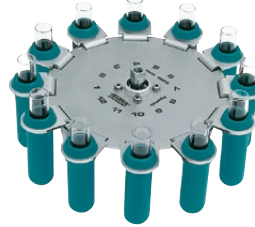

## Swing-out rotor, 12-place





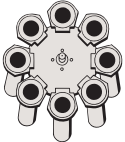





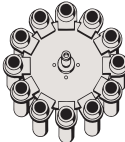











✧ 55° (with carriers 1127)  
✧ 60° (with carriers 1122)  
✧ 80° (with carriers 1621)

n = 5,000 min<sup>-1</sup>  
max. RCF 4,193

**Cat. No. (without carriers) 1628**

capacity in ml	15	50
Ø x L in mm	17x120	29x115
<b>Cat. No.</b>	<b>0509</b>	<b>0513</b>
		
<b>rotor</b> <b>Cat. No. 1617</b>		
<b>Cat. No.</b>	<b>1462-A</b>	<b>-</b>
boring Ø x L in mm	17 x 84	30 x 94.5
tubes per rotor	8	
max. RCF <sup>2)</sup>	3,857	
radius in mm	138	
run-up in sec	20	
run-down in sec, braked	19	
temperature in °C <sup>1)</sup>	-10	

capacity in ml	5	10	15	2.6–3.4	2.7–3	4–5.5	7.5–8.5	1.6–5	4–7	8.5–10
Ø x L in mm	12x75	17x70	17x100	13x65	11x66	15x75	15x92	13x75	16x75	16x100
<b>Cat. No.</b>	<b>0553<sup>2)</sup></b>	<b>2079</b>	<b>0518<sup>2)</sup></b>	<b>blood collection/urine tubes</b>						
										
<b>rotor</b> <b>Cat. No. 1628</b>										
<b>Cat. No.</b>	<b>1127</b>	<b>1122</b>	<b>1621</b>	<b>1127</b>	<b>1122</b>	<b>1621</b>	<b>1127</b>	<b>1122</b>	<b>1621</b>	
boring Ø x L in mm	13.2x53	17.5x53	17.5x79	13.2x53	17.5x53	17.5x79	13.2x53	17.5x53	17.5x79	
tubes per rotor	12									
max. RCF <sup>2)</sup>	3,494	3,522	4,193	3,494	3,522	4,193	3,494	3,522	4,193	
radius in mm	125	126	150	125	126	150	125	126	150	
run-up in sec	16									
run-down in sec, braked	16									
temperature in °C <sup>1)</sup>	-15		-10	-15	-15	-10	-15	-15	-10	

# ACCESSORIES



## Swing-out rotor, 4-place



∠ 90°  
n = 4,000 min<sup>-1</sup>  
max. RCF 1,896



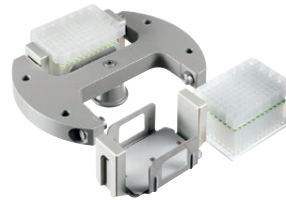

**Cat. No.** (without carriers) **1645**





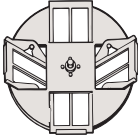

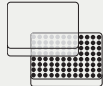
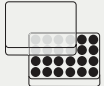

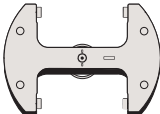

## Swing-out rotor, 2-place

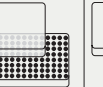

∠ 90°  
n = 4,000 min<sup>-1</sup>  
max. RCF 2,218

**Cat. No.** (without carriers) **1460**

DxWxH in mm	86x128x15/17.5	86x128x22	
<b>Cat. No.</b>	<b>MTP</b>	<b>CP</b>	
			
<b>rotor</b> <b>Cat. No. 1645</b>			
<b>Cat. No.</b>	<b>4345</b>		
boring Ø x L in mm	-		
plates per rotor	4		
max. RCF <sup>2)</sup>	1,896		
radius in mm	106		
run-up in sec	20		
run-down in sec, braked	19		
temperature in °C <sup>1)</sup>	-16		

DxWxH in mm	86x128x15/17.5	86x128x22	86x128x44.5	86x128x46	86x128x83	59x84x11	82x124x20	-
capacity in ml	-							
<b>Cat. No.</b>	<b>MTP</b>	<b>CP</b>	<b>DWP</b>	<b>MS</b>	<b>QP</b>	<b>Microtest plate (Terasaki)</b>	<b>PCR plate, 96 wells</b>	<b>PCR strips</b>
								
<b>rotor</b> <b>Cat. No. 1460</b>								
<b>Cat. No.</b>	<b>1453-A</b>						<b>1453-A + 1485</b>	
boring Ø x L in mm	-							
plates / strips per rotor	10	8	6	2	2	2	4	2
max. RCF <sup>2)</sup>	2,218							
radius in mm	124							
run-up in sec	40							
run-down in sec, braked	45							
temperature in °C <sup>1)</sup>	-6							

<sup>1)</sup> Lowest attainable temperature in precooled refrigerated centrifuges at max. speed. Lower temperatures can be attained by reducing the speed.

<sup>2)</sup> Please note that the RCF values indicated refer only to rotor performance. The max. permissible RCF of tubes used should be verified with the individual manufacturers. The max. RCF for glass tubes annotated with footnote <sup>2)</sup> is 4,000.

<sup>3)</sup> Tested by the TÜV in conformity with DIN EN 61010, section 2 - 020.

# ACCESSORIES



## Angle rotor, 12-place



∠ 45°  
n = 15,000 min<sup>-1</sup>  
max. RCF 16,602

Cat. No. 1612

## Angle rotor, 24-place



∠ 40°  
n = 15,000 min<sup>-1</sup>  
max. RCF 21,382

Cat. No. 1420-B

capacity in ml	0.2	0.4	0.5	0.8	1.5	2.0
∅ x L in mm	6x18	6x45	8x30	8x45	11x38	
Cat. No.	-	-	-	-	2078	0536
lid incl.						
rotor Cat. No. 1612						
Cat. No.	2024		2023	2031 <sup>11)</sup>		-
boring ∅ x L in mm	6x40		8x40	10.2x19		11.4x39
tubes per rotor	12					
max. RCF <sup>2)</sup>	16,602					
radius in mm	66					
run-up in sec	25					
run-down in sec, braked	23					
temperature in °C <sup>1)</sup>	-10					

capacity in ml	0.2	0.4	0.5	0.8	1.5	2.0	0.5
∅ x L in mm	6x18	6x45	8x30	8x45	11x38		10.7x36
Cat. No.	-	-	-	-	2078	0536	Pediatric
lid incl.							
rotor Cat. No. 1420-B							
Cat. No.	2024		2023	2031 <sup>11)</sup>		-	0788 <sup>12)</sup>
boring ∅ x L in mm	6x40		8x40	10.2x19		11.2x42.6	11.2x39
tubes per rotor	24						12
max. RCF <sup>2)</sup>	21,382						20,376
radius in mm	85						81
run-up in sec	25						
run-down in sec, braked	24						
temperature in °C <sup>1)</sup>	-4						

## lid optional for rotor 1420-B



with bio-containment<sup>3)</sup>,  
autoclavable

Cat. No. 2425



with bio-containment<sup>3)</sup>,  
autoclavable  
and phenol-resistant

Cat. No. 2423

<sup>11)</sup> For centrifugation at high speeds, we recommend to use form-fitting, phenol-resistant adapters 2031.

<sup>12)</sup> Packed in units of 15 pieces.

# ACCESSORIES



## Angle rotor, 30-place



with bio-containment<sup>3)</sup>,  
phenol-resistant

∠ 45°  
n = 14,000 min<sup>-1</sup>  
max. RCF 21,255

Cat. No. 1689-A

## Angle rotor, 8-place



∠ 45°  
n = 4,500 min<sup>-1</sup>  
max. RCF 3,305

Cat. No. (without adapters) 1418

capacity in ml	0.2	0.4	0.5	0.8	1.5	2.0	0.5	
∅ x L in mm	6x18	6x45	8x30	8x45	11x38		10.7x36	
Cat. No.	-	-	-	-	2078	0536	Pediatric	
lid with bio-containment <sup>3)</sup> incl.								
rotor Cat. No. 1689-A								
Cat. No.	2024		2023		2031 <sup>11)</sup>	-	0788 <sup>12)</sup>	
boring ∅ x L in mm	6x40		8x40		10.2x19	11.2x40.9	11.2x39	
tubes per rotor	30						15	
max. RCF <sup>2)</sup>	21,255						20,376	
radius in mm	97						93	
run-up in sec	35							
run-down in sec, braked	31							
temperature in °C <sup>1)</sup>	0							

capacity in ml	5	15	1.1–1.4	2.6–3.4	2.7–3	9–10	1.6–5	4–7	8.5–10	12	15	50	12	50	50
∅ x L in mm	12x75	17x100	8x66	13x65	11x66	16x92	13x75	13x100	16x100	17x102	17x120	29x115	17x100	29x115	29x107
Cat. No.	0553 <sup>2)</sup>	0518 <sup>2)</sup>	blood collection / urine tubes								0509	0513	-	-	0546
rotor Cat. No. 1418															
Cat. No.	1467	1467	1467			1467	1467	1467	1467	1467	1467	1468	1467	1468	
boring ∅ x L in mm	17.4x91											30.2x92		17.4x91	30.2x92
tubes per rotor	32											8	32	8	
max. RCF <sup>2)</sup>	2,762	3,215	2,762			3,215	2,762	3,305	3,215	3,215	3,283	3,147	3,215	3,147	
radius in mm	122	142	122			142	122	146	142		145	139	142	139	
run-up in sec	30														
run-down in sec, braked	31														
temperature in °C <sup>1)</sup>	-11														

<sup>1)</sup> Lowest attainable temperature in precooled refrigerated centrifuges at max. speed. Lower temperatures can be attained by reducing the speed.

<sup>2)</sup> Please note that the RCF values indicated refer only to rotor performance. The max. permissible RCF of tubes used should be verified with the individual manufacturers. The max. RCF for glass tubes annotated with footnote <sup>2)</sup> is 4,000.

<sup>3)</sup> Tested by the TÜV in conformity with DIN EN 61010, section 2 - 020.



# ACCESSORIES















## Angle rotor, 6-place









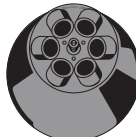

illustrated with 6-place adapter set 1646

∠ 35°  
n = 9,000 min<sup>-1</sup>  
max. RCF 9,509

### Cat. No. 1620A

capacity in ml	0.5	1.5	2.0	3	15	50	75	94	7.5–8.5	9–10	10	8.5–10
∅ x L in mm	10.7 x 36	11 x 38		10 x 60	17 x 100	34 x 100	35 x 105	38 x 102	15 x 92	16 x 92	15 x 102	16 x 100
<b>Cat. No.</b>	<b>Pediatric</b>	<b>2078</b>	<b>0536</b>	-	<b>0518<sup>2)</sup></b>	<b>0521<sup>2)</sup></b>	<b>0548</b>	<b>0549</b>	<b>blood/urine tubes</b>			
 <b>rotor</b> <b>Cat. No. 1620A</b>												
<b>Cat. No.</b>	<b>1449</b>				<b>1451</b>	<b>1463</b>	-		<b>1451</b>			
boring ∅ x L in mm	11.4 x 39				17.5 x 92	35 x 89	38.6 x 90.2		17.5 x 92			
tubes per rotor	24				6	6	6		6			
max. RCF <sup>2)</sup>	9,237				8,784	9,327	9,509		8,784			
radius in mm	102				97	103	105		97			
run-up in sec	30											
run-down in sec, braked	30											
temperature in °C <sup>1)</sup>	-11											

capacity in ml	5	15	50		10	30	50	85	
∅ x L in mm	17 x 59	17 x 120	29 x 115		16 x 80	26 x 95	29 x 107	38 x 106	
<b>Cat. No.</b>	-	<b>0509</b>	<b>0513</b>		-	<b>0545</b>	<b>0546</b>	<b>0547</b>	
 <b>rotor</b> <b>Cat. No. 1620A</b>									
<b>Cat. No.</b>	<b>1476</b>	<b>1466</b>	<b>1454</b>	<b>1646<sup>13)</sup></b>	<b>1448</b>	<b>1447</b>	<b>1446</b>	-	
boring ∅ x L in mm	17 x 51	17 x 106	29.8 x 97		-	16.5 x 74	26 x 85	29 x 92	38.6 x 90.2
tubes per rotor	6		3	6	12	6			
max. RCF <sup>2)</sup>	8,603	8,965			8,784	8,603	9,056	9,509	
radius in mm	95	99			97	95	100	105	
run-up in sec	30								
run-down in sec, braked	30								
temperature in °C <sup>1)</sup>	-11								

<sup>1)</sup> For centrifugation at high speeds, we recommend to use form-fitting, phenol-resistant adapters 2031.

<sup>2)</sup> Packed in units of 15 pieces.

<sup>13)</sup> 6-place adapter set for conical 50 ml tubes with screw cap.

# ACCESSORIES











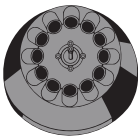

















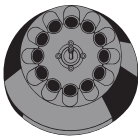



## Angle rotor, 12-place



∠ 35°  
n = 6,000 min<sup>-1</sup>  
max. RCF 4,146

### Cat. No. 1613

capacity in ml	0.5	1.5	2.0	4	5	6	15	1.1–1.4	2.6–3.4	2.7–3	4.5–5
∅ x L in mm	10.7 x 36	11 x 38		10 x 88	12 x 75	12 x 82	17 x 100	8 x 66	13 x 65	11 x 66	11 x 92
<b>Cat. No.</b>	<b>Pediatric</b>	<b>2078</b>	<b>0536</b>	-	<b>0553<sup>2)</sup></b>	<b>0501<sup>2)</sup></b>	<b>0518<sup>2)</sup></b>	<b>blood collection/urine tubes</b>			
 <b>rotor</b> <b>Cat. No. 1613</b>											
											
<b>Cat. No.</b>	<b>2x1063-6 (6 pcs.)</b>			<b>6305</b>	<b>1054-A</b>			<b>1054-A</b>			
boring ∅ x L in mm	11 x 35			11.5 x 67.5	13.5 x 60		17.7 x 88	13.5 x 60			17.7 x 88
tubes per rotor	12										
max. RCF <sup>2)</sup>	2,777	2,737		3,502	3,300		4,146	3,300			4,146
radius in mm	69	68		87	82		103	82			103
run-up in sec	15										
run-down in sec, braked	15										
temperature in °C <sup>1)</sup>	-16										

capacity in ml	4.9	7.5–8.5	9–10	10	1.6–5	4–7	8	8.5–10	5	15
∅ x L in mm	13 x 90	15 x 92	16 x 92	15 x 102	13 x 75	13 x 100	16 x 125	16 x 100	17 x 59	17 x 120
<b>Cat. No.</b>	<b>blood collection/urine tubes</b>								-	<b>0509</b>
 <b>rotor</b> <b>Cat. No. 1613</b>										
										
<b>Cat. No.</b>	-				<b>1054-A</b>	<b>1058</b>	-	-	<b>1064</b>	-
boring ∅ x L in mm	17.7 x 88				13.5 x 60	13.5 x 79	17.7 x 88		17 x 25	17.7 x 88
tubes per rotor	12						6	12		6
max. RCF <sup>2)</sup>	4,146				3,300	4,146			3,180	4,146
radius in mm	103				82	103			79	103
run-up in sec	15									
run-down in sec, braked	15									
temperature in °C <sup>1)</sup>	-16									

<sup>1)</sup> Lowest attainable temperature in precooled refrigerated centrifuges at max. speed. Lower temperatures can be attained by reducing the speed.

<sup>2)</sup> Please note that the RCF values indicated refer only to rotor performance. The max. permissible RCF of tubes used should be verified with the individual manufacturers. The max. RCF for glass tubes annotated with footnote <sup>2)</sup> is 4,000.

# ACCESSORIES



## Angle rotor, 12-place



$\sphericalangle$  35°  
 $n = 12,000 \text{ min}^{-1}$   
 max. RCF 16,582











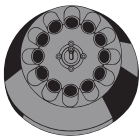







Cat. No. 1615











## Hematocrit rotor, 24-place



$n = 15,000 \text{ min}^{-1}$   
 max. RCF 21,382

Cat. No. 1650



capacity in ml	0.5	1.5	2.0	4	5	6	15	1.1–1.4	2.6–3.4	2.7–3	4.5–5	4.9	7.5–10
Ø x L in mm	10.7 x 36	11 x 38		10 x 88	12 x 75	12 x 82	17 x 100	8 x 66	13 x 65	11 x 66	11 x 92	13 x 90	15/16 x 92
Cat. No.	Pediatric	2078	0536	-	0553 <sup>2)</sup>	0501 <sup>2)</sup>	0518 <sup>2)</sup>	blood collection/urine tubes					
													
rotor Cat. No. 1615													
Cat. No.	2 x 1063-6 (6 pcs.)			6305	1054-A		-	1054-A		-			
boring Ø x L in mm	11 x 35			11.5 x 67.5	13.5 x 60		17.7 x 88	13.5 x 60		17.7 x 88			
tubes per rotor	12												
max. RCF <sup>2)</sup>	11,108	10,947		14,006	13,201		16,582	13,201		16,582			
radius in mm	69	68		87	82		103	82		103			
run-up in sec	40												
run-down in sec, braked	40												
temperature in °C <sup>1)</sup>	-2												

capacity in ml	10	1.6–5	4–7	8–10	5	15
Ø x L in mm	15 x 102	13 x 75	13 x 100	16 x 100/125	17 x 59	17 x 120
Cat. No.	blood/urine tubes				-	0509
						
rotor Cat. No. 1615						
Cat. No.	-	1054-A	1058	-	1064	1647 <sup>14)</sup>
boring Ø x L in mm	17.7 x 88	13.5 x 60	13.5 x 79	17.7 x 88	17 x 25	17 x 104
tubes per rotor	12			12	6	6
max. RCF <sup>2)</sup>	16,582	13,201	16,582		12,718	15,455
radius in mm	103	82	103		79	96
run-up in sec	40					
run-down in sec, braked	40					
temperature in °C <sup>1)</sup>	-2					

standard capillaries, heparinised	basic	self-sealing and mylar-coated
Cat. No.	2074	1071
lid as evaluation disk incl.		
rotor Cat. No. 1650	sealing putty	
Cat. No.	2077	-
boring Ø x L in mm	-	
capillaries per rotor	24	
max. RCF <sup>2)</sup>	21,382	
radius in mm	85	
run-up in sec	13	
run-down in sec, braked	9	
temperature in °C <sup>1)</sup>	-1	

<sup>14)</sup> Set of 6 carriers. For accommodating conical 15 ml tubes with screw cap, remove 6 opposite carriers from rotor No. 1615 and replace them with adapters No. 1647.

# TECHNICAL DATA

TECHNOLOGY	UNIVERSAL 320		UNIVERSAL 320R <sup>&gt;1</sup>		
<b>Benchtop centrifuge, without rotor</b>	<b>classic</b>		<b>cooled</b>		
Power supply <sup>&gt;1</sup>	200–240 V 1 ~	100–127 V 1 ~	200–240 V1 ~	240 V 1 ~	115–127 V 1 ~
Frequency	50–60 Hz	50–60 Hz	50 Hz	60 Hz	60 Hz
Consumption	400 VA	400 VA	800 VA		950 VA
Emission, Immunity	EN/IEC 61326-1, class B	FCC class B	EN/IEC 61326-1, class B		FCC class B
 Max. capacity	4 x 200 ml / 6 x 94 ml				
 Max. RPM (speed)	15,000 min <sup>-1</sup>				
max. RCF	21,382				
Running time	1 sec–99 min : 59 sec, ∞ continuous run, short cycle mode (impulse key)				
Dimensions (HxWxD)	346x401x529 mm	346x401x529 mm	346x407x698 mm		346x407x698 mm
Weight	approx. 31 kg	approx. 31 kg	approx. 53 kg		approx. 53 kg
<b>Refrigeration</b>					
Temperature control, infinitely variable	-	-	from -20 to +40 °C		from -20 to +40 °C
<b>Cat. No.</b>	<b>1401</b>	<b>1401-01</b>	<b>1406</b>		<b>1406-01</b>

<sup>>1</sup> Other voltages on request.

<sup>>2</sup> Available model variants on request.



Hettich centrifuges comply with all relevant EU standards in effect and conform to the European level of quality and safety for medical devices. Evidence is provided by national and international test marks such as IEC 61010 or the CE conformity. The ISO 9001, ISO 13485 and ISO 14001 certificates accredited to the company bear witness to the extreme care and responsibility Hettich puts into the manufacturing of centrifuges and their accessories.



Our certification as an “Authorised Economic Operator” enables accelerated customs clearance.



↓  
[www.hettichlab.com](http://www.hettichlab.com)

**Hettich**  
 LAB TECHNOLOGY